

# FURNITURE

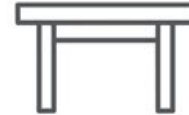

Learn the English names for types of furniture.

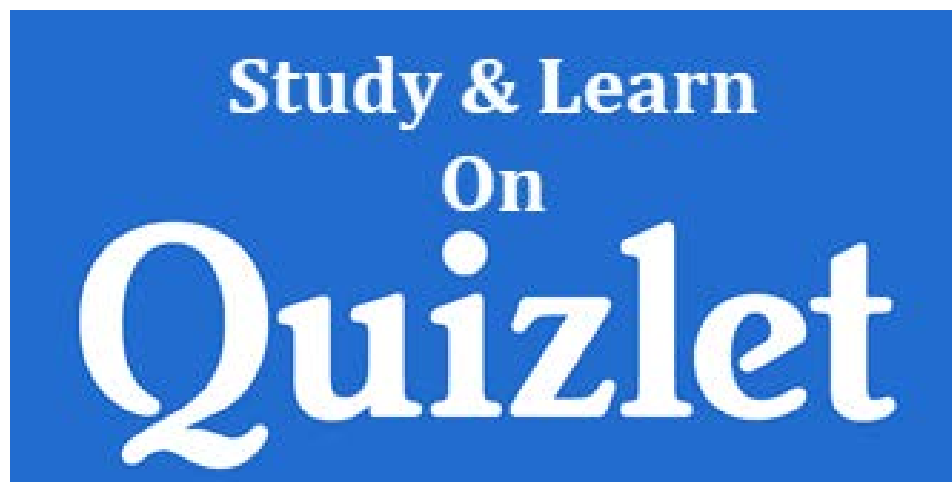

# FURNITURE

What types of furniture do you find at home?

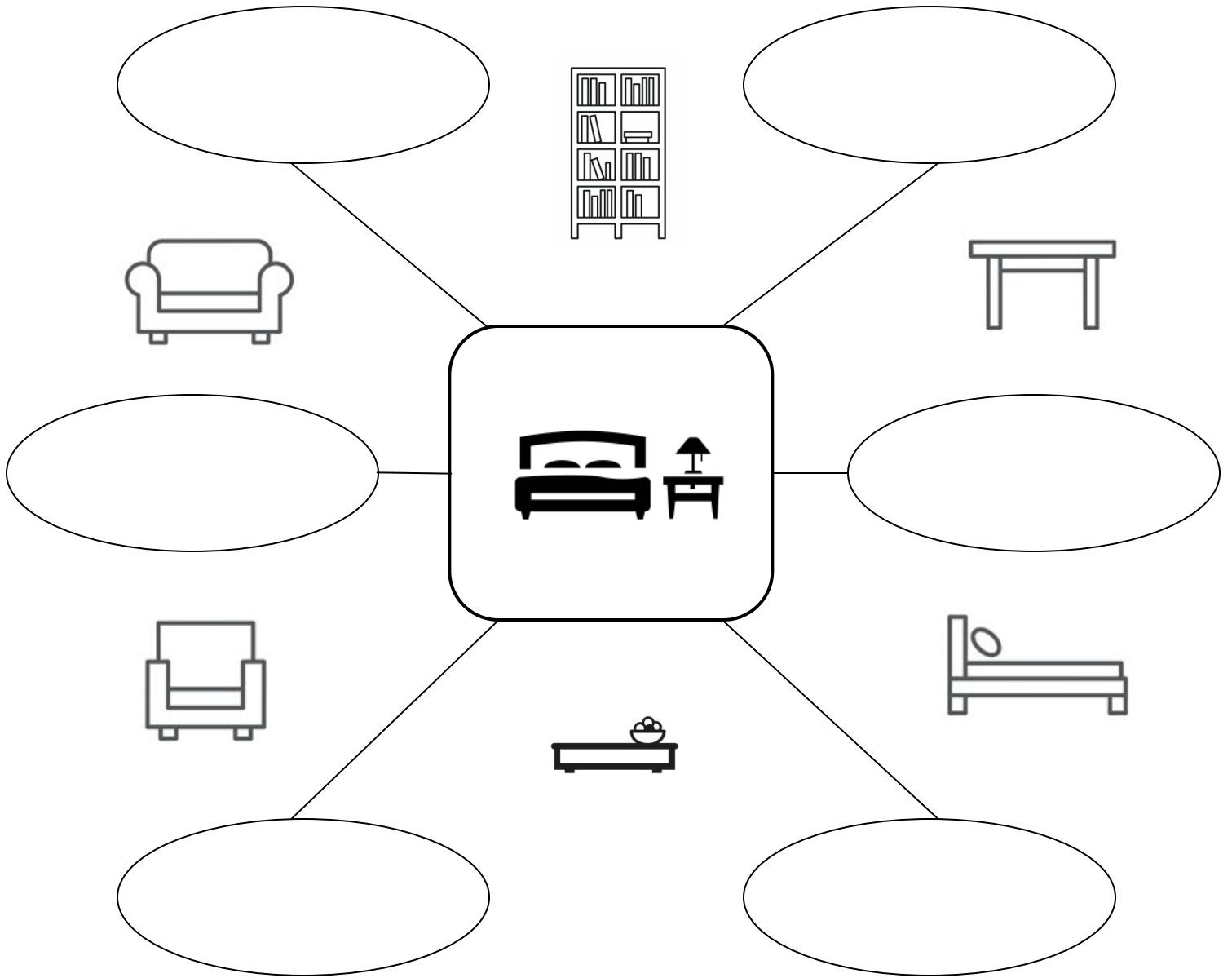



# The Sandpiper

Draw in and / or label where you'll put your furniture.

- Kitchen table      Coffee table      Beds
- Lamps      Bookcase      Couch
- Chairs      Armchairs      Curtains
- Dressers      End table      Bench
- Mirrors      Rugs      Desk
- Bookcase      Clock      Divan
- Bunkbed      Wardrobe      Deck chairs

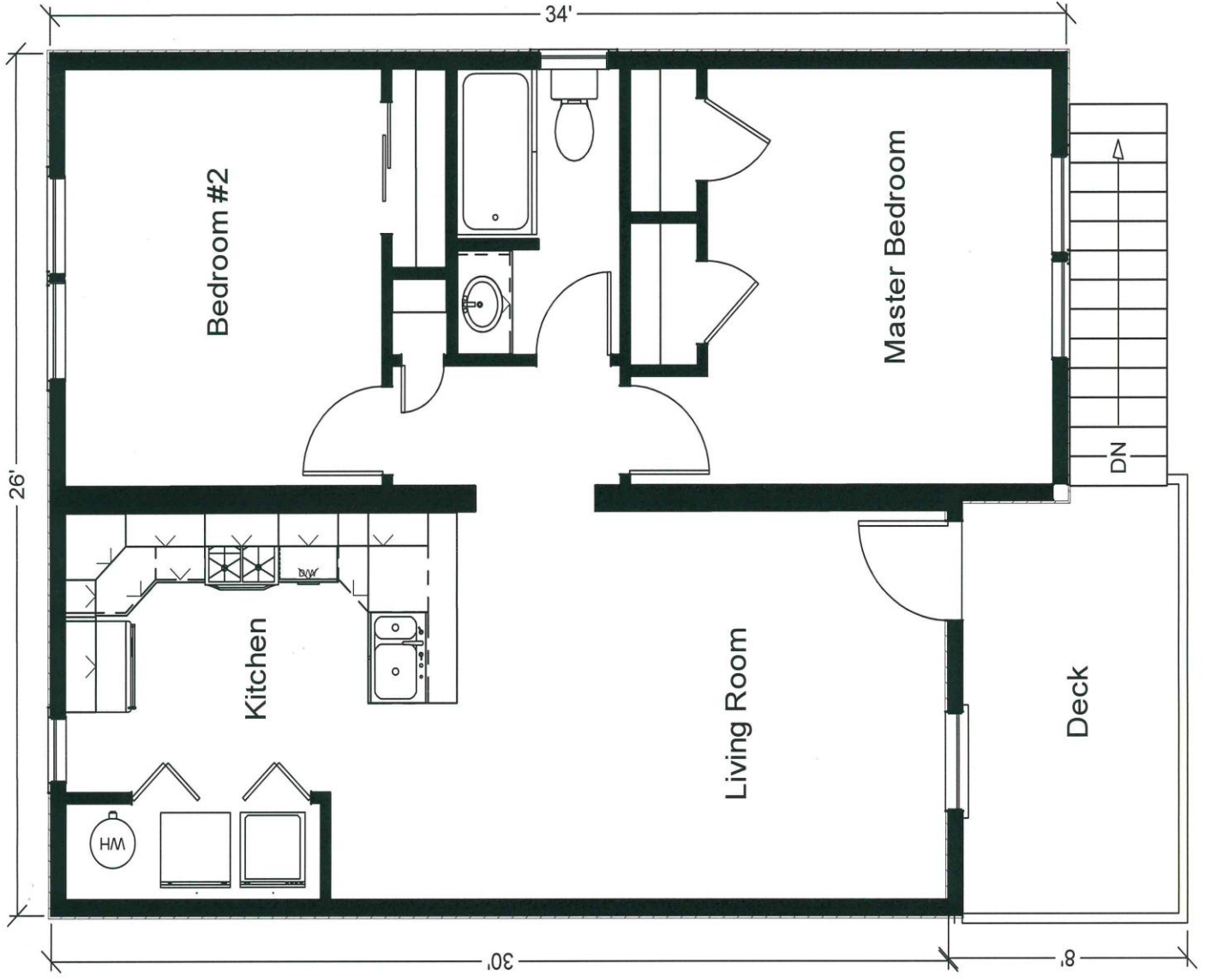

NAME: \_\_\_\_\_

Date: \_\_\_\_\_

Directions: Match the furniture word with the correct picture.

# Furniture

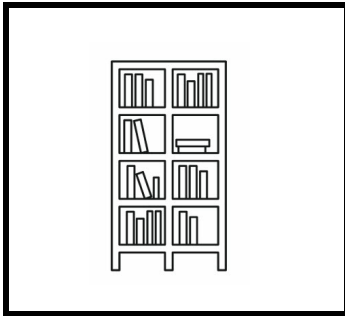

desk

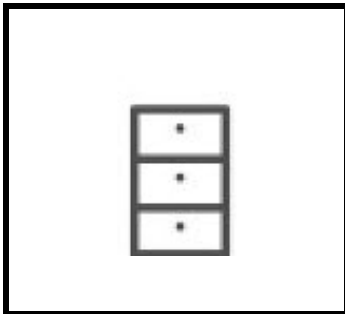
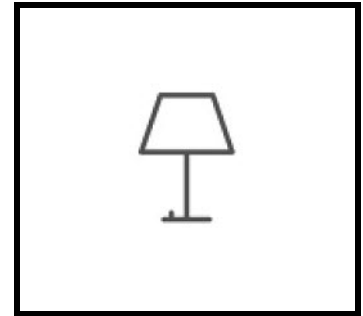

couch

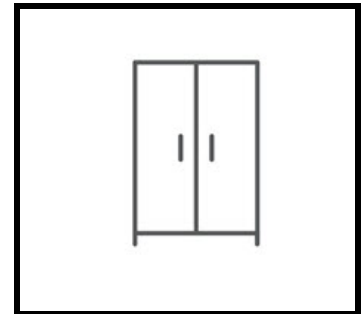

table

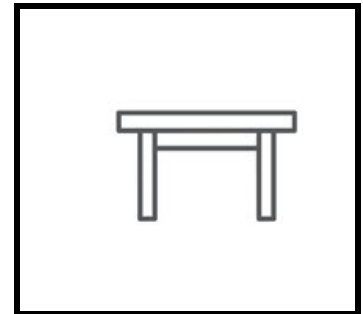

chair



bed



coffee table

bookcase

lamp

wardrobe

dresser

NAME: \_\_\_\_\_

Date: \_\_\_\_\_

Directions: Draw the piece of furniture and match with the correct word.

# Furniture



desk



couch



table



chair

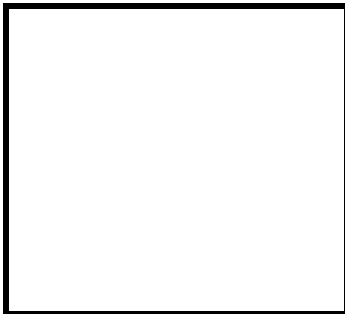

bed

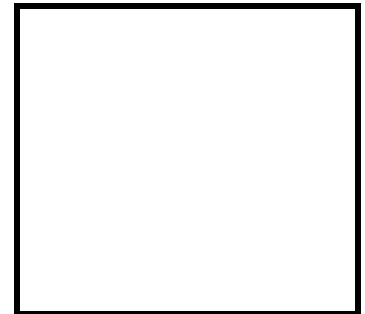

coffee table

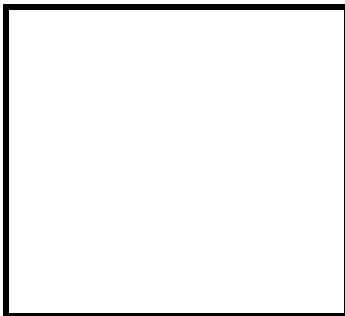

bookcase

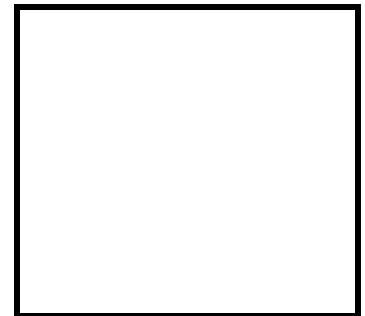

lamp

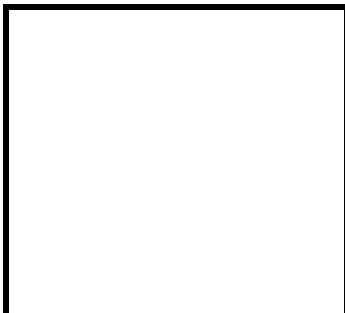

wardrobe

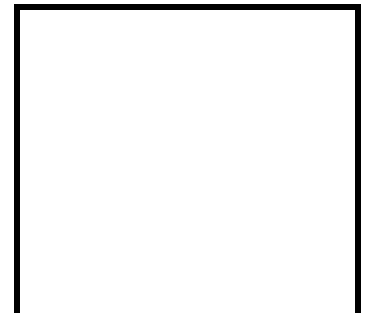

dresser

NAME: \_\_\_\_\_

Date: \_\_\_\_\_

Directions: Write the furniture word and match with the correct picture.

# Furniture

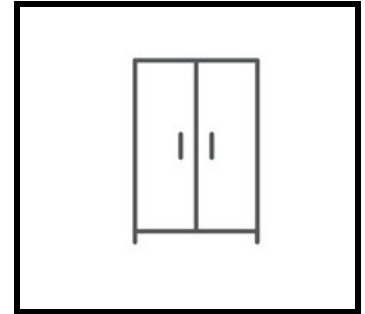
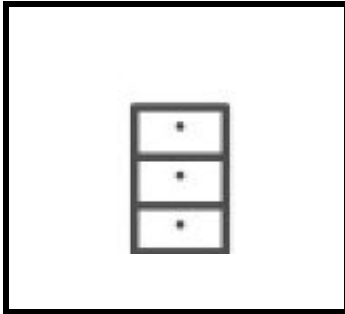
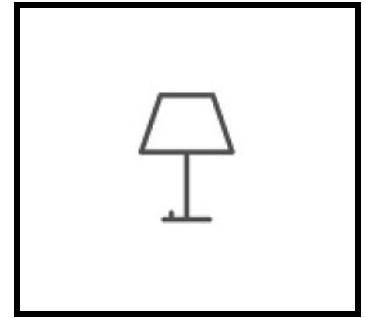
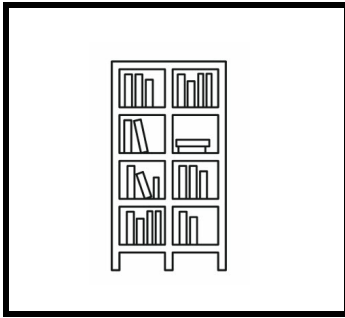

NAME: \_\_\_\_\_

Date: \_\_\_\_\_

Directions: Match the furniture word with the correct picture.

# Furniture

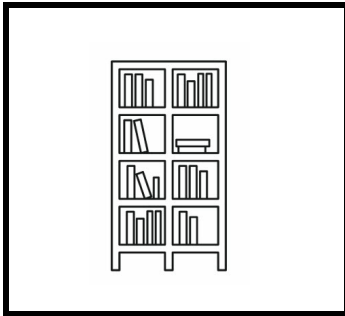

bookcase

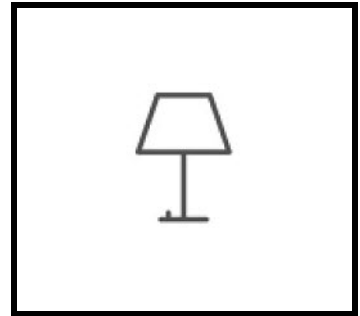

lamp

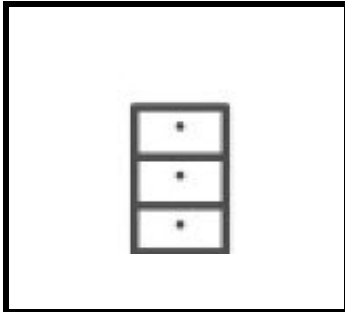

dresser

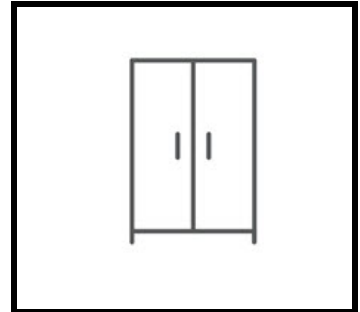

wardrobe



chair

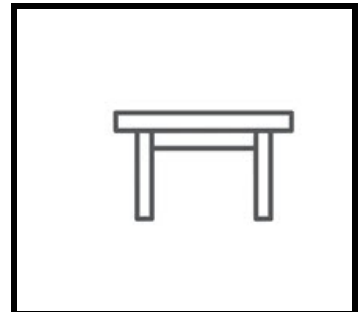

table



desk



bed



couch



coffee table

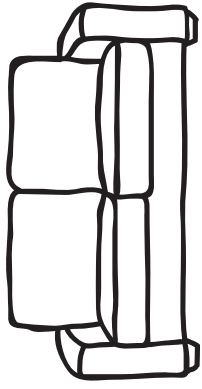

\_\_\_\_\_

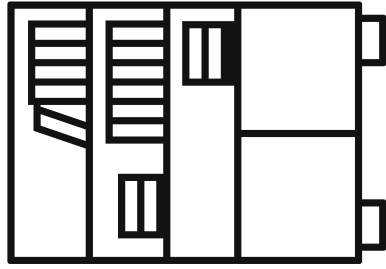

\_\_\_\_\_



\_\_\_\_\_

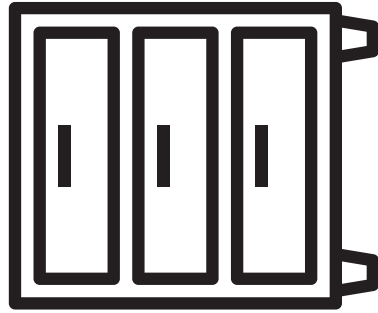

\_\_\_\_\_

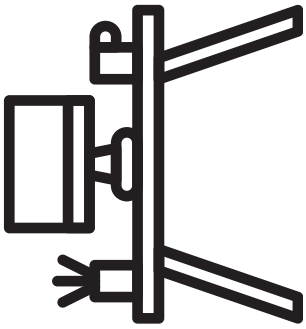

\_\_\_\_\_

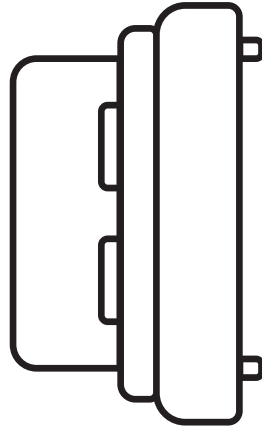

\_\_\_\_\_

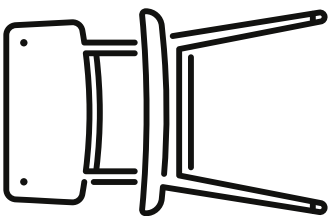

\_\_\_\_\_

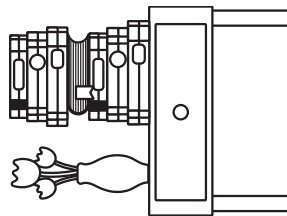

\_\_\_\_\_



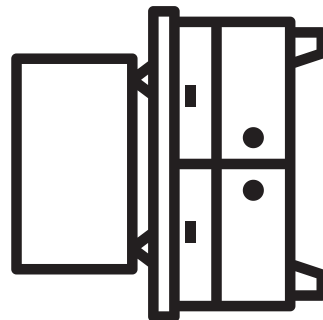
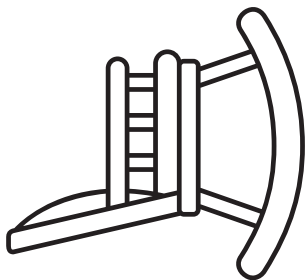
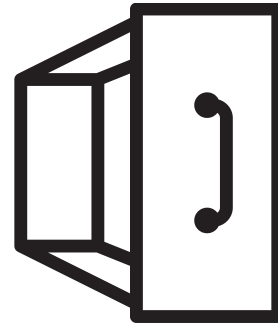
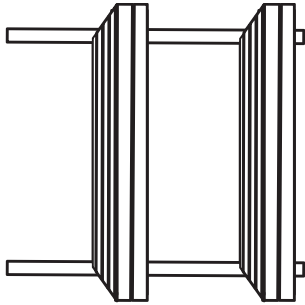
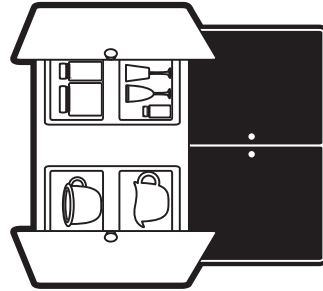
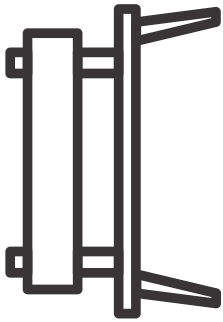
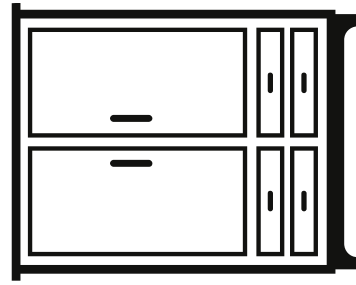

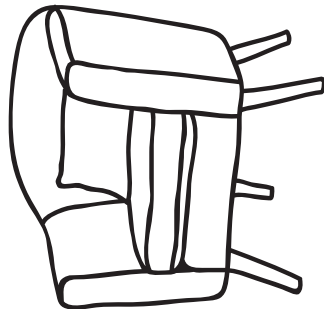
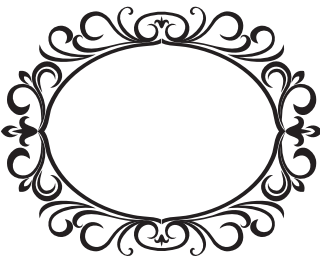
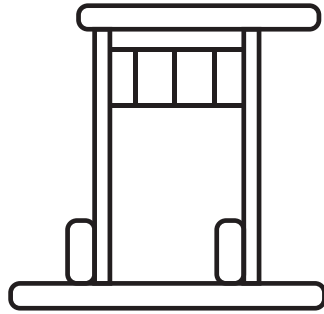
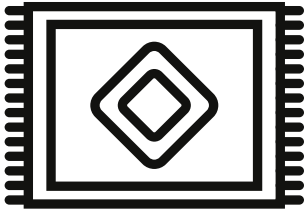
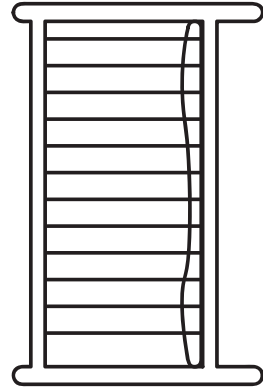
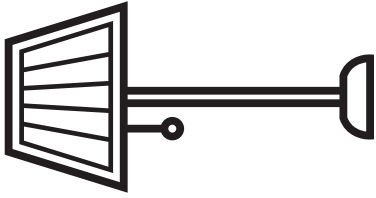
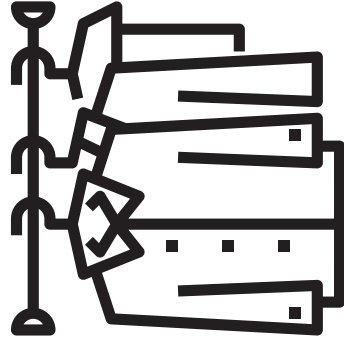
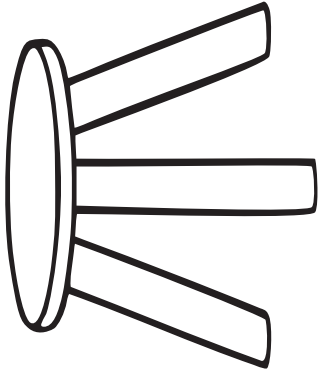

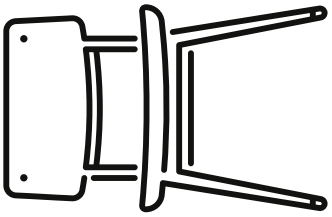

**chair**

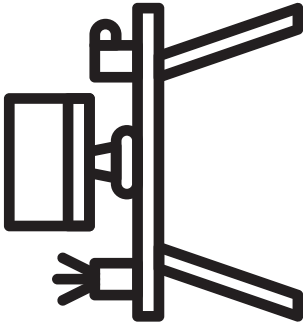

**desk**

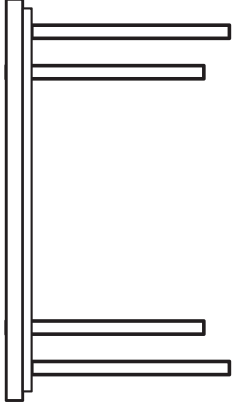

**table**

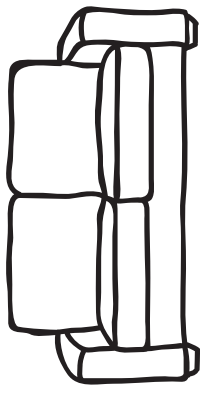

**couch**

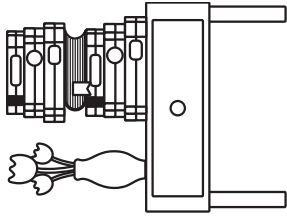

**end table**

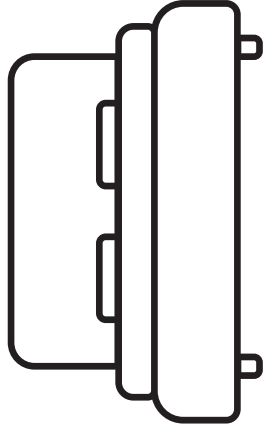

**bed**



**dresser**

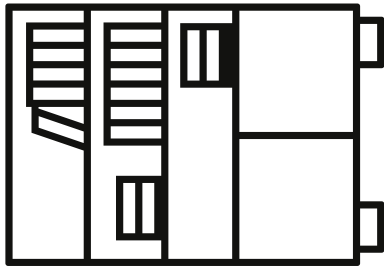

**bookcase**

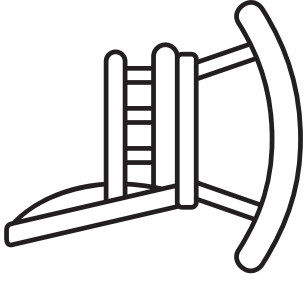

**rocking  
chair**

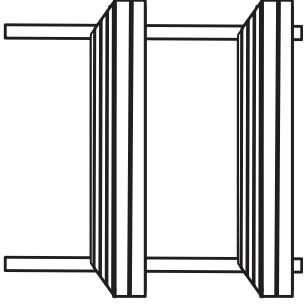

**shelf**

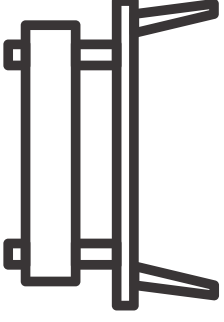

**bench**



**coffee  
table**

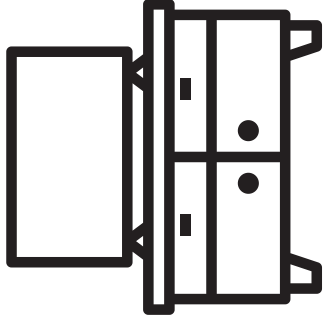

**TV stand**

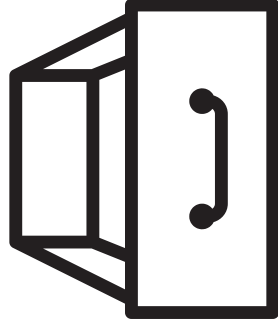

**drawer**

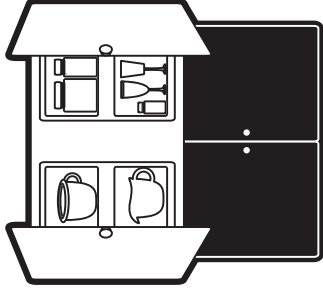

**cupboard**

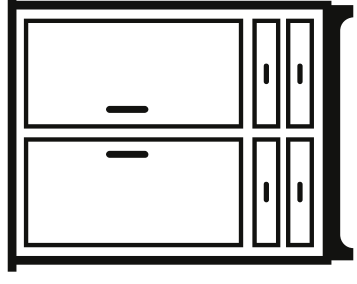

**wardrobe**

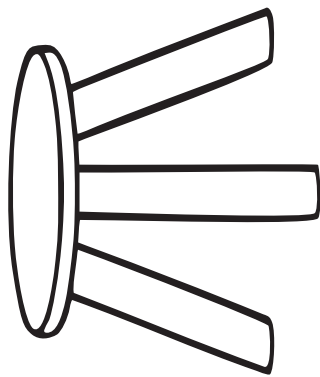

**stool**

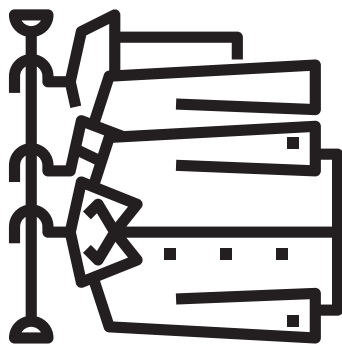

**closet**

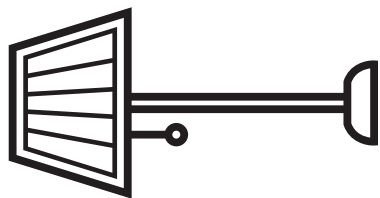

**lamp**

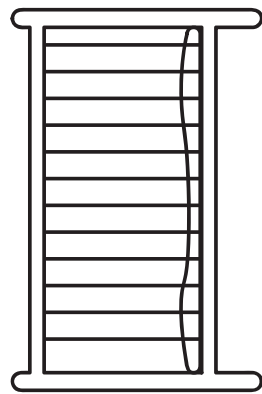

**crib**

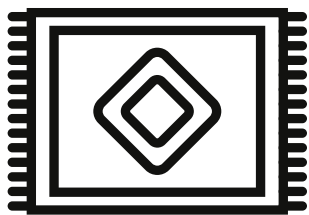

**rug**

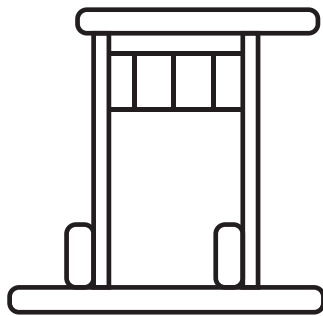

**bunk bed**

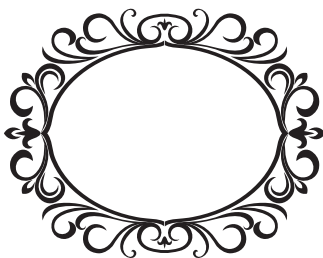

**mirror**

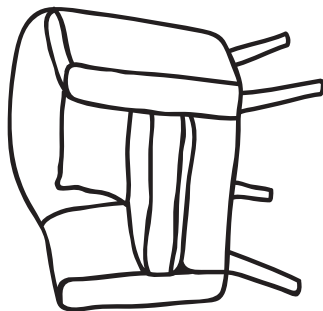

**armchair**

# Please visit us!

The largest and most complete lesson library on the web.

ELT

buzz 

Everything in English language teaching



SUBSCRIBE 

*Follow  
-US-*



Follow Us On

Teachers Pay Teachers